

ANDERSON POWER CONNECTORS

ANDERSONPOWER™

Anderson Power Products, is an international leader in high power interconnect solutions. In 1877, Anderson began as a small company in Boston, MA making innovative trolley and railway power designs. Today as a subsidiary of IDEAL® Industries APP connectors are used around the world across many markets including: Telecom & IT Equipment, Motive Power, and Alternative Energy. APP offers a range of connectors to meet power, signal, & ground needs in protected or environmentally exposed applications.

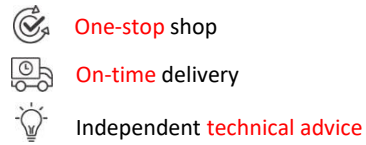

SBE series

SBE connectors build on the capability of the SB connectors that handle two primary power contacts with the capacity to have up to 8 auxiliary power / signal contacts. The centers of the connector housing's feature a location for either: two PP15-45 housings and contacts, an innovative 1x4 auxiliary accessory, or two PPMX housings that can accommodate up to 8 aux contacts. In addition, the housings meet IEC 60950 & IEC60529 touch safe requirements.

Sequencing within auxiliary positions is possible using the 4 pin lengths available in the 1x4 auxiliary accessory however the auxiliary contacts mate last / un-mate first in relationship to the power contacts. The SBE connector housings are molded from a chemical resistant PBT/PC blend resin allowing them to meet EN1175-1 requirement and are tested to EN1175-1 standards.



SBE80





SBE160



SBE320



-  One-stop shop
-  On-time delivery
-  Independent technical advice



SBE80 



Connectors = Housing + wire contacts (set)		
Color	6 AWG	4 AWG
Yellow	SBE80YEL16MM	SBE80YEL25MM
Orange	SBE80ORN16MM	SBE80ORN25MM
Red	SBE80RED16MM	SBE80RED25MM
Gray	SBE80GRA16MM	SBE80GRA25MM



Standard housings		
Color	Ordering code	Description
Yellow	SBE80YEL-BK	Housing SBE 80 – Yellow
Orange	SBE80ORN-BK	Housing SBE 80 – Orange
Red	SBE80RED-BK	Housing SBE 80 – Red
Gray	SBE80GRA-BK	Housing SBE 80 – Gray

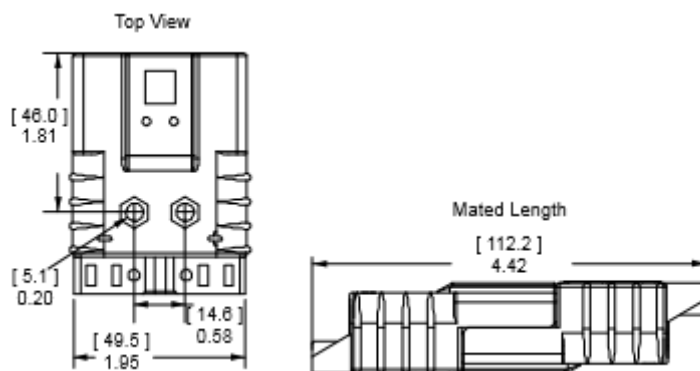



 **Silver plated wire contacts**

Section	Ordering code	Description
AWG 6	1339G1-BK	Main Contact SBE 80 – 6 AWG (16 mm ²)
AWG 4	1339G4-BK	Main Contact SBE 80 – 4 AWG (25 mm ²)

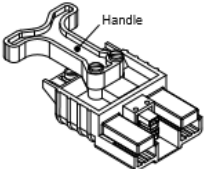
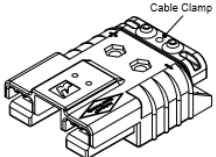
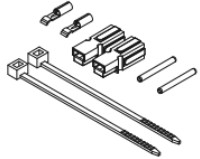
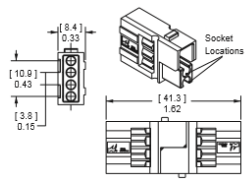
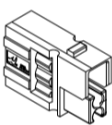
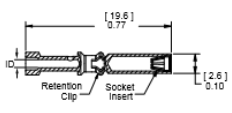

Accessories

Picture	Ordering code	Description
	5912-BK 5910-BK 5913-BK	Reducing Bushing APP 6 AWG - 8 AWG Reducing Bushing APP 6 AWG - 12-10 AWG Reducing Bushing APP 6 AWG - 16-14 AWG
	SBE80HDLRED	Handle SBE 80 – Red
	SBE80CLPYEL SBE80CLPORN SBE80CLPRED SBE80CLPWHT	Cable Clamp SBE80 – Yellow Cable Clamp SBE80 – Orange Cable Clamp SBE80 – Red Cable Clamp SBE80 – White
	6344	Powerpole Auxiliary Kit 16 to 12 AWG Contact
	441G3 441G1 441G2	1x4 Auxiliary Kit 12 AWG 1x4 Auxiliary Kit 16 to 14 AWG 1x4 Auxiliary Kit 20 to 16 AWG * Auxiliary Kits include (1) Auxiliary Housing, (2) Standard Length Pin Contacts, (2) Socket Contacts, (2) Retaining Pins and (1) Retaining Clip.
	444G1	Aux. Holder Housing - SBE/SBX 1x4
	PM16S12S32 PM16S1416S32 PM16S1620S32 PM16S2024S32	<u>Socket Contacts for 1x4 Auxiliary Connector</u> PowerMod Socket 12 AWG (2,5 mm ²) PowerMod Socket 16-14 AWG (1,0-1,5 mm ²) PowerMod Socket 20-16 AWG (0,75-1,0 mm ²) PowerMod Socket 24-20 AWG (0,50-0,75 mm ²)



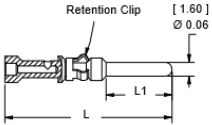
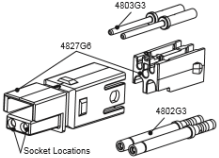
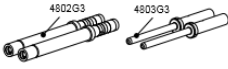
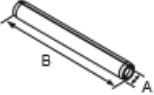

-  One-stop shop
-  On-time delivery
-  Independent technical advice



	<p>PM16P12S30 PM16P1416S30 PM16P1620S30 PM16P2024S30 PM16P12A30 PM16P1416A30 PM16P1620A30 PM16P2024A30 PM16P12C30 PM16P1416C30 PM16P1620C30 PM16P2024C30</p>	<p><u>Pin Contacts for 1x4 Auxiliary Connector</u> PowerMod Pin12 AWG, Standard Length 7.7 mm PowerMod Pin 16-14 AWG, Standard Length 7.7mm PowerMod Pin 20-16 AWG, Standard Length 7.7mm PowerMod Pin 24-20 AWG, Standard Length 7.7mm PowerMod Pin 12 AWG, Pre-Mate 9.3 mm PowerMod Pin 16-14 AWG, Pre-Mate 9.3mm PowerMod Pin 20-16 AWG, Pre-Mate 9.3mm PowerMod Pin 24-20 AWG, Pre-Mate 9.3mm PowerMod Pin 12 AWG, Post-Mate 6,6mm PowerMod Pin 16-14 AWG, Post-Mate 6,6mm PowerMod Pin 20-16 AWG, Post-Mate 6,6mm PowerMod Pin 24-20 AWG, Post-Mate 6,6mm</p>
	<p>4850G6</p>	<p>PPMX Auxiliary Kit 24 to 20 AWG</p> <p>The PPMX auxiliary connector allows up to 8 auxiliary circuits to be used in the SBE®, SBO®, & SBX® housings. There are 4 auxiliary circuits per PPMX connector and two PPMX housings fit into the auxiliary port in the main connector housing</p>
	<p>4803G3-BK 4802G3-BK</p>	<p>Pin Contact for PPMX – 24 to 20 AWG Socket Contact for PPMX – 24 to 20 AWG</p>
	<p>110G9-BK</p>	<p>Retaining Pin for SBE 80</p>
	<p>6396G1</p>	<p>Air Adapter SBE 80/160/320 – Black</p>



-  One-stop shop
-  On-time delivery
-  Independent technical advice



SBE160 



Connectors = Housing + wire contacts (set)		
Color	1/0 AWG	2 AWG
Yellow	E6377G1	E6377G2
Orange	E6376G1	E6376G2
Red	E6379G1	E6379G2
Gray	E6374G1	E6374G2
Blue	E6375G1	E6375G2
Green	E6391G1	E6391G2
Black	E6389G1	E6389G2



Standard housings		
Color	Ordering code	Description
Yellow	E6383G1	Housing SBE 160 – Yellow
Orange	E6382G1	Housing SBE 160 – Orange
Red	E6385G1	Housing SBE 160 – Red
Gray	E6380G1	Housing SBE 160 – Gray
Blue	E6381G1	Housing SBE 160 – Blue
Green	E6390G1	Housing SBE 160 – Green
Black	E6392G1	Housing SBE 160 – Black

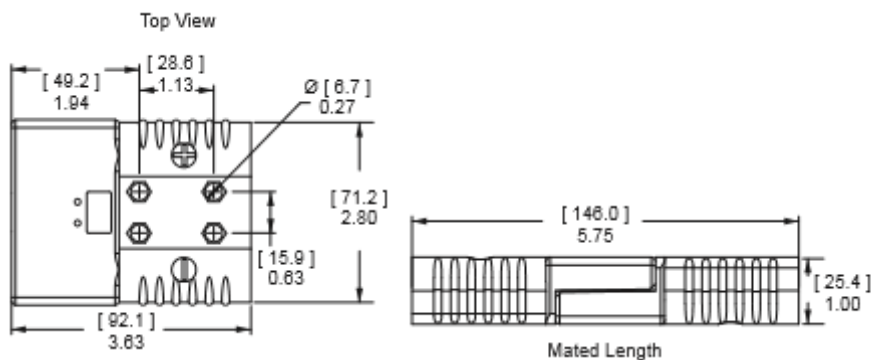

 **Silver plated wire contacts**

Section	Ordering code	Description
2 AWG	6384G2-BK	Main Contact SBE 160/SBX 175 – 2 AWG (35 mm ²)
1/0 AWG	6384G1-BK	Main Contact SBE 160/SBX 175 – 1/0 AWG (50 mm ²)

Accessories

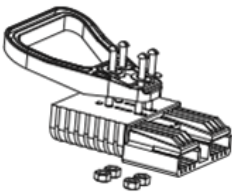
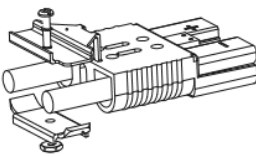
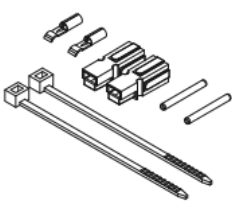
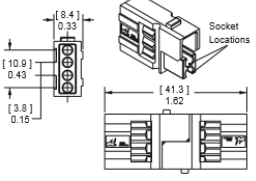
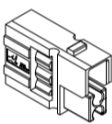
Picture	Ordering code	Description
	5687-BK 5690-BK 5693-BK 5663-BK 5648-BK	Reducing Bushing APP 1/0 AWG – 1 AWG Reducing Bushing APP 1/0 AWG – 2 AWG Reducing Bushing APP 1/0 AWG – 4 AWG Reducing Bushing APP 1/0 AWG – 6 AWG Reducing Bushing APP 1/0 AWG – 10-8 AWG
	995G1-GRAY 995G3-RED	Handle SBE 160/SBX 175 – Gray Handle SBE 160/SBX 175 – Red
	945G2	Cable Clamp, self-attaching for discrete conductor – 0.62”-0.22”
	6344	Powerpole Auxiliary Kit 16 to 12 AWG Contact
	441G3 441G1 441G2	1x4 Auxiliary Kit 12 AWG 1x4 Auxiliary Kit 16 to 14 AWG 1x4 Auxiliary Kit 20 to 16 AWG * Auxiliary Kits include (1) Auxiliary Housing, (2) Standard Length Pin Contacts, (2) Socket Contacts, (2) Retaining Pins and (1) Retaining Clip.
	444G1	Aux. Holder Housing – SBE/SBX 1x4





One-stop shop





On-time delivery

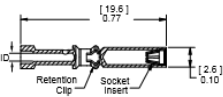
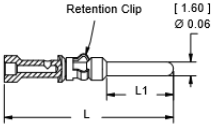
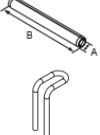
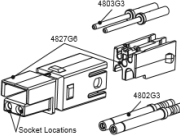

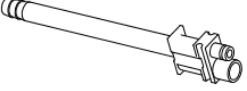
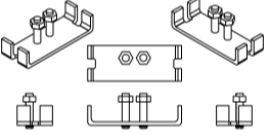
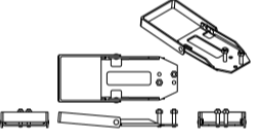
Independent technical advice

	<p>PM16S12S32 PM16S1416S32 PM16S1620S32 PM16S2024S32</p>	<p><u>Socket Contacts for 1x4 Auxiliary Connector</u> PowerMod Socket 12 AWG (2,5 mm²) PowerMod Socket 16-14 AWG (1,0-1,5 mm²) PowerMod Socket 20-16 AWG (0,75-1,0 mm²) PowerMod Socket 24-20 AWG (0,50-0,75 mm²)</p>
	<p>PM16P12S30 PM16P1416S30 PM16P1620S30 PM16P2024S30 PM16P12A30 PM16P1416A30 PM16P1620A30 PM16P2024A30 PM16P12C30 PM16P1416C30 PM16P1620C30 PM16P2024C30</p>	<p><u>Pin Contacts for 1x4 Auxiliary Connector</u> PowerMod Pin 12 AWG, Standard Length 7.7 mm PowerMod Pin 16-14 AWG, Standard Length 7.7mm PowerMod Pin 20-16 AWG, Standard Length 7.7mm PowerMod Pin 24-20 AWG, Standard Length 7.7mm PowerMod Pin 12 AWG, Pre-Mate 9.3 mm PowerMod Pin 16-14 AWG, Pre-Mate 9.3mm PowerMod Pin 20-16 AWG, Pre-Mate 9.3mm PowerMod Pin 24-20 AWG, Pre-Mate 9.3mm PowerMod Pin 12 AWG, Post-Mate 6,6mm PowerMod Pin 16-14 AWG, Post-Mate 6,6mm PowerMod Pin 20-16 AWG, Post-Mate 6,6mm PowerMod Pin 24-20 AWG, Post-Mate 6,6mm</p>
	<p>110G9-BK 2-8675P2</p>	<p>Retaining Pin for SBE 160/SBX 175 Retaining Clip for SBE 160/SBX 175</p>
	<p>4850G6</p>	<p>PPMX Auxiliary Kit 24 to 20 AWG</p> <p>The PPMX auxiliary connector allows up to 8 auxiliary circuits to be used in the SBE®, SBO®, & SBX® housings. There are 4 auxiliary circuits per PPMX connector and two PPMX housings fit into the auxiliary port in the main connector housing</p>
	<p>4803G3-BK 4802G3-BK</p>	<p>Pin Contact for PPMX – 24 to 20 AWG Socket Contact for PPMX – 24 to 20 AWG</p>
	<p>6396G1</p>	<p>Air Adapter SBE 80/160/320 – Black</p>
	<p>993G2</p>	<p>Manual Release SBE 160/SBX 175 with hardware kit – Battery</p>
	<p>994G2</p>	<p>Manual Release SBE 160/SBX 175 with hardware kit – Charger/Truck</p>



-  One-stop shop
-  On-time delivery
-  Independent technical advice



SBE320



Connectors = Housing + wire contacts (set)								
Color	300/350MCM	4/0 AWG	95 mm ²	3/0 AWG	70 mm ²	2/0 AWG	50 mm ²	35 mm ²
Yellow	E6364G11	E6364G3	E6364G9	E6364G2	E6364G8	E6364G1	E6364G7	E6364G6
Orange	E6369G11	E6369G3	E6369G9	E6369G2	E6369G8	E6369G1	E6369G7	E6369G6
Red	E6347G11	E6347G3	E6347G9	E6347G2	E6347G8	E6347G1	E6347G7	E6347G6
Gray	E6345G11	E6345G3	E6345G9	E6345G2	E6345G8	E6345G1	E6345G7	E6345G6
Blue	E6346G11	E6346G3	E6346G9	E6346G2	E6346G8	E6346G1	E6346G7	E6346G6
Green	E6348G11	E6348G3	E6348G9	E6348G2	E6348G8	E6348G1	E6348G7	E6348G6
Black	E6363G11	E6363G3	E6363G9	E6363G2	E6363G8	E6363G1	E6363G7	E6363G6
Brown	E6334G11	E6334G3	E6334G9	E6334G2	E6334G8	E6334G1	E6334G7	E6334G6
Purple	E6365G11	E6365G3	E6365G9	E6365G2	E6365G8	E6365G1	E6365G7	E6365G6



Standard housings		
Color	Ordering code	Description
Yellow	E6362-BK	Housing SBE320 – Yellow
Orange	E6339-BK	Housing SBE320 – Orange
Red	E6352-BK	Housing SBE320 – Red
Gray	E6350-BK	Housing SBE320 – Gray
Blue	E6351-BK	Housing SBE320 – Blue
Green	E6353-BK	Housing SBE320 – Green
Black	E6361-BK	Housing SBE320 – Black
Brown	E6336-BK	Housing SBE320 – Brown
Purple	E6349-BK	Housing SBE320 – Purple

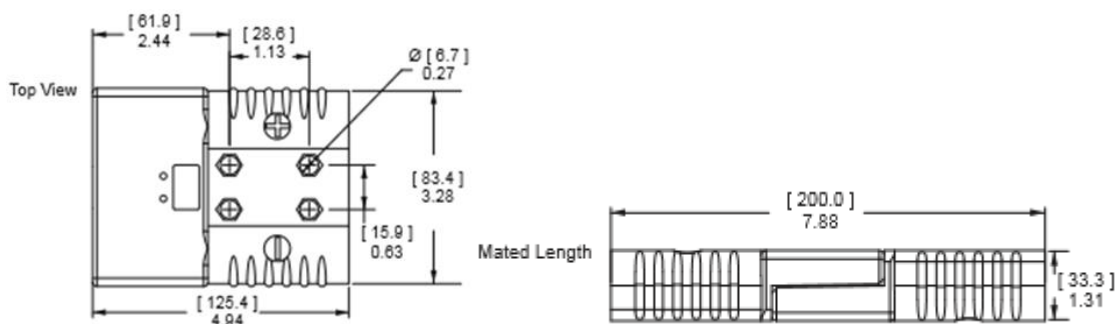



 **Silver plated wire contacts**

Section	Ordering code	Description
2 AWG	6394-BK	Main Contact SBE320 / SBX350 – 2 AWG (35 mm ²)
50 mm ²	1341G1-BK	Main Contact SBE320 / SBX350 – 50 mm ² "Standard"
70 mm ²	1341G2-BK	Main Contact SBE320 / SBX350 – 70 mm ² "Standard"
2/0 AWG	6354-BK	Main Contact SBE320 / SBX350 – 2/0 AWG (70 mm ²)
95 mm ²	1341G3	Main Contact SBE320 / SBX350 – 95 mm ² "Standard"
3/0 AWG	6355-BK	Main Contact SBE320 / SBX350 – 3/0 AWG (95 mm ²)
4/0 AWG	6356-BK	Main Contact SBE320 / SBX350 – 4/0 AWG (120 mm ²)
300/350 MCM	6358-BK	Main Contact SBE320 / SBX350 – 300/350 MCM (150 mm ²)

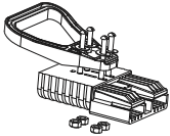
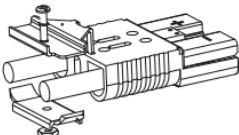
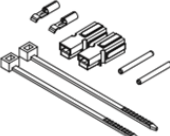
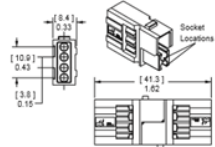
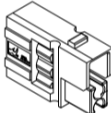

Accessories

Picture	Ordering code	Description
	5918-BK 5687-BK 5690-BK 5693-BK 5663-BK 5648-BK 5920-BK	Reducing Bushing APP 2/0 AWG - 1/0 AWG Reducing Bushing APP 1/0 AWG - 1 AWG Reducing Bushing APP 1/0 AWG - 2 AWG Reducing Bushing APP 1/0 AWG - 4 AWG Reducing Bushing APP 1/0 AWG - 6 AWG Reducing Bushing APP 1/0 AWG - 10-8 AWG Reducing Bushing APP 2 AWG - 6 AWG
	995G2-GRAY 995G4-RED	Handle SBE 320/SBX 350 – Gray Handle SBE 320/SBX 350 – Red
	911G2	Cable Clamp, self-attaching for discrete conductor – 0.85”-0.67”
	6305G1 6310G1	Powerpole Auxiliary Kit 16 to 12 AWG Contact Powerpole Auxiliary Kit 20 to 16 AWG Contact
	440G3 440G1 440G2	1x4 Auxiliary Kit 12 AWG 1x4 Auxiliary Kit 16 to 14 AWG 1x4 Auxiliary Kit 20 to 16 AWG * Auxiliary Kits include (1) Auxiliary Housing, (2) Standard Length Pin Contacts, (2) Socket Contacts, (2) Retaining Pins and (1) Retaining Clip.
	444G1	Aux. Holder Housing – SBE/SBX 1x4



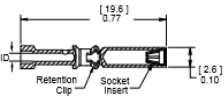
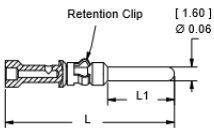
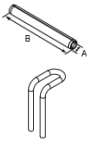
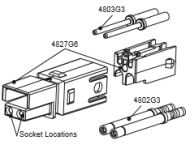

-  One-stop shop
-  On-time delivery
-  Independent technical advice

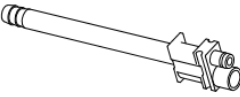
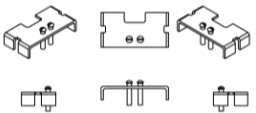
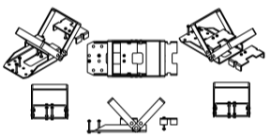

	<p>PM16S12S32 PM16S1416S32 PM16S1620S32 PM16S2024S32</p>	<p><u>Socket Contacts for 1x4 Auxiliary Connector</u> PowerMod Socket 12 AWG (2,5 mm²) PowerMod Socket 16-14 AWG (1,0-1,5 mm²) PowerMod Socket 20-16 AWG (0,75-1,0 mm²) PowerMod Socket 24-20 AWG (0,50-0,75 mm²)</p>
	<p>PM16P12S30 PM16P1416S30 PM16P1620S30 PM16P2024S30 PM16P12A30 PM16P1416A30 PM16P1620A30 PM16P2024A30 PM16P12C30 PM16P1416C30 PM16P1620C30 PM16P2024C30</p>	<p><u>Pin Contacts for 1x4 Auxiliary Connector</u> PowerMod Pin 12 AWG, Standard Length 7.7 mm PowerMod Pin 16-14 AWG, Standard Length 7.7mm PowerMod Pin 20-16 AWG, Standard Length 7.7mm PowerMod Pin 24-20 AWG, Standard Length 7.7mm PowerMod Pin 12 AWG, Pre-Mate 9.3 mm PowerMod Pin 16-14 AWG, Pre-Mate 9.3mm PowerMod Pin 20-16 AWG, Pre-Mate 9.3mm PowerMod Pin 24-20 AWG, Pre-Mate 9.3mm PowerMod Pin 12 AWG, Post-Mate 6,6mm PowerMod Pin 16-14 AWG, Post-Mate 6,6mm PowerMod Pin 20-16 AWG, Post-Mate 6,6mm PowerMod Pin 24-20 AWG, Post-Mate 6,6mm</p>
	<p>110G59-BK 2-8675P1</p>	<p>Retaining Pin for SBE 320/SBX 350 Retaining Clip for SBE 320/SBX 350</p>
	<p>4850G6</p>	<p>PPMX Auxiliary Kit 24 to 20 AWG The PPMX auxiliary connector allows up to 8 auxiliary circuits to be used in the SBE®, SBO®, & SBX® housings. There are 4 auxiliary circuits per PPMX connector and two PPMX housings fit into the auxiliary port in the main connector housing</p>
	<p>4803G3-BK 4802G3-BK</p>	<p>Pin Contact for PPMX – 24 to 20 AWG Socket Contact for PPMX – 24 to 20 AWG</p>
	<p>6396G1</p>	<p>Air Adapter SBE 80/160/320 – Black</p>
	<p>993G1</p>	<p>Manual Release SBE 320/SBX 350 with hardware kit – Battery</p>
	<p>994G1</p>	<p>Manual Release SBE 320/SBX 350 with hardware kit – Charger/Truck</p>



-  One-stop shop
-  On-time delivery
-  Independent technical advice

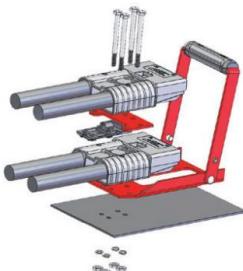
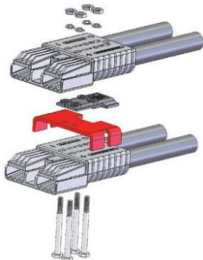

 Exploded view diagram of the 994G5 Double Stack Truck/Charger Bracket. It shows two blue Anderson Power connectors being mounted onto a red metal frame with a handle, which is attached to a grey base plate. Several screws and nuts are shown as separate components.	994G5	SBE320/SBX350 Double Stack Truck/Charger Bracket
 Exploded view diagram of the 993G5 Double Stack Battery Bracket. It shows two blue Anderson Power connectors being mounted onto a red metal frame with a handle, which is attached to a grey base plate. Several screws and nuts are shown as separate components.	993G5	SBE320/SBX350 Double Stack Battery Bracket

