

---

## Anderson Power™ Connectors

---

# ANDERSON POWER™

Anderson Power Products® (APP®), is an international leader in high power interconnect solutions. In 1877, Anderson began as a small company in Boston, MA making innovative trolley and railway power designs. Today as a subsidiary of IDEAL® Industries APP connectors are used around the world across many markets including: Telecom & IT Equipment, Motive Power, and Alternative Energy. APP offers a range of connectors to meet power, signal, & ground needs in protected or environmentally exposed applications.



One-stop shop



On-time delivery



Independent technical advice



Dust- Water- Shock

## Sealed Connectors SBSX-75A



Dust- Water- Shock

Built on the success and proven reliability of the SBS® Series for both lead acid and lithium-ion battery technology, the NEW SBS®X-75A Sealed Waterproof Connector Series comes with two power contacts rated up to 135A, accepting wire sizes from 12 to 4 AWG (2.5 to 25mm<sup>2</sup>) along with up to 4 auxiliaries for 24 to 14 AWG (0.50 to 1.5mm<sup>2</sup>) wire sizes, and the durability of up to 5,000 mating cycles. Product is rated for IP 68 ingress protection certification in the mated condition, or with the use of covers in the unmated condition. Positive metal latches help safeguard against accidental disconnects that may be caused by vibration, while built in cable clamp allows for strain relief on wires.

### FEATURES:





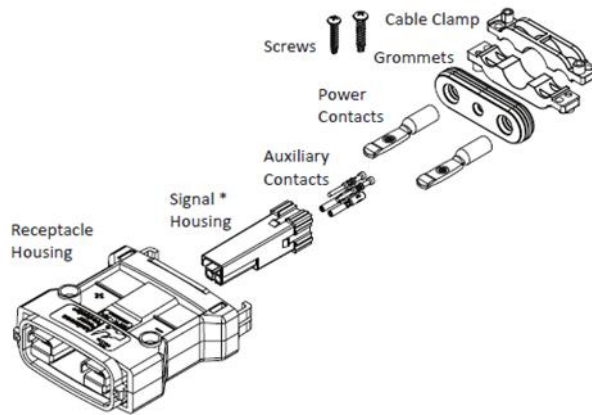

- 2 Power & up to 4 Signals
- Rated for IP 68 Ingress Protection due to the use of O-rings and grommet seals
- Positive Latching to Secure Connection for Vibration Applications
- Operating Temperatures -20°C to 105°C
- 5,000 Mating Cycles
- Each individual signal holder can be oriented in four different ways (hood on the top, hood on the bottom, hood on the left and hood on the right) while installed in the housing, which provides a total combination of 4 unique keying options. Each housing will offer 4 unique colours in order to differentiate between voltages.



## Wire-to-Wire



<b>Receptacle Housing Kit</b>		
Item	Ordering code	Description
	SBSX75A-REC-KIT-RED	SBSX-75A Receptacle Kit - Red Signal Housing
	SBSX75A-REC-KIT-BLU	SBSX-75A Receptacle Kit - Blue Signal Housing
	SBSX75A-REC-KIT-GRA	SBSX-75A Receptacle Kit - Gray Signal Housing
	SBSX75A-REC-KIT-BLK	SBSX-75A Receptacle Kit - Black Signal Housing



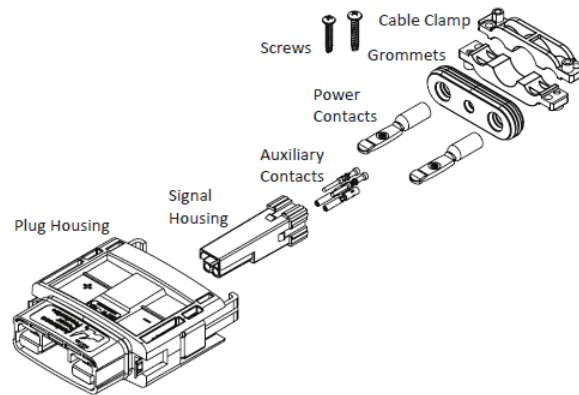



<b>Loose parts included in the kits</b>		
	SBSX75A-REC-BLK	SBSX-75A Female Receptacle Housing
	2-8841P1	SBSX-75A Cable Clamp - Set of 2
	H1120P62	SBSX-75A Cable Clamp Screws
	2-8840P1	SBSX-75A Signal Housing - Red
	2-8840P2	SBSX-75A Signal Housing - Blue
	2-8840P3	SBSX-75A Signal Housing - Gray
	2-8840P4	SBSX-75A Signal Housing - Black



### Plug Housing Kit

Item	Ordering code	Description
	SBSX75A-PLUG-KIT-RED	SBSX-75A Plug Kit - Red Signal Housing
	SBSX75A-PLUG-KIT-BLU	SBSX-75A Plug Kit - Blue Signal Housing
	SBSX75A-PLUG-KIT-GRA	SBSX-75A Plug Kit - Gray Signal Housing
	SBSX75A-PLUG-KIT-BLK	SBSX-75A Plug Kit - Black Signal Housing

### Loose parts included in the kits

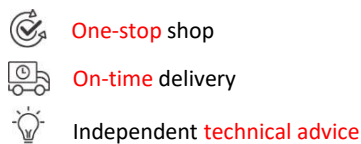

	SBSX75A-PLUG-BLK	SBSX-75A Male Plug Housing
	2-8841P1	SBSX-75A Cable Clamp - Set of 2
	H1120P62	SBSX-75A Cable Clamp Screws
	2-8840P1	SBSX-75A Signal Housing - Red
	2-8840P2	SBSX-75A Signal Housing - Blue
	2-8840P3	SBSX-75A Signal Housing - Gray
	2-8840P4	SBSX-75A Signal Housing - Black



### Main Contacts Silver Plated

	1339G4-BK	Main contact – AWG 4 (21.2 mm <sup>2</sup> )
	1339G2-BK	Main contact – AWG 6 (13.3 mm <sup>2</sup> )
	1339G5-BK	Main contact – AWG 8 (8.4 mm <sup>2</sup> )
	1339G3-BK	Main contact – AWG 10/12 (5.3 – 3.3 mm <sup>2</sup> )

### Contacts for Auxiliary 4 Positions

	PM16P1416S30	PowerMod Pin AWG 16-14 Au.25 Standard Length 7.7mm
	PM16P1620S30	PowerMod Pin AWG 20-16 Au.25 Standard Length 7.7mm
	PM16P2024S30	PowerMod Pin AWG 24-20 Au.25 Standard Length 7.7mm
	PM16P1416A30	PowerMod Pin AWG 16-14 Au.25 Pre-Mate 9.3mm
	PM16P1620A30	PowerMod Pin AWG 20-16 Au.25 Pre-Mate 9.3mm
	PM16P2024A30	PowerMod Pin AWG 24-20 Au.25 Pre-Mate 9.3mm
	PM16P1416C30	PowerMod Pin AWG 16-14 Au.25 Post-Mate 6.6mm
	PM16P1620C30	PowerMod Pin AWG 20-16 Au.25 Post-Mate 6.6mm
	PM16P2024C30	PowerMod Pin AWG 24-20 Au.25 Post-Mate 6.6mm
	PM16S1416S32	PowerMod Socket AWG 16-14 Au.75
	PM16S1620S32	PowerMod Socket AWG 20-16 Au.75
	PM16S2024S32	PowerMod Socket AWG 24-20 Au.75



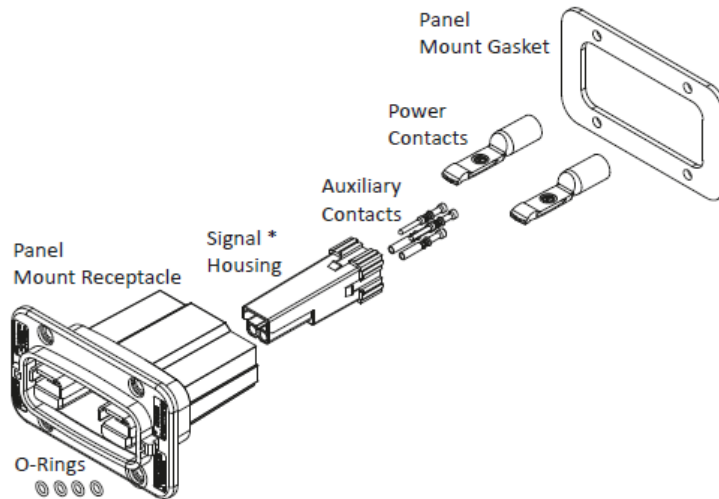



## Panel Mount





### Panel Mount Receptacle Housing Kit





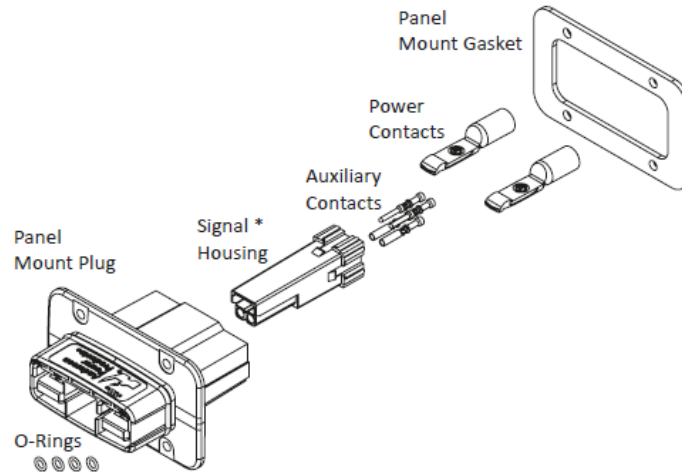

Item	Ordering code	Description
	SBSX75A-PMREC-KIT-RED	SBSX-75A Panel Mount Receptacle Kit - Red Signal Housing
	SBSX75A-PMREC-KIT-BLU	SBSX-75A Panel Mount Receptacle Kit - Blue Signal Housing
	SBSX75A-PMREC-KIT-GRA	SBSX-75A Panel Mount Receptacle Kit - Gray Signal Housing
	SBSX75A-PMREC-KIT-BLK	SBSX-75A Panel Mount Receptacle Kit - Black Signal Housing

### Loose parts included in the kits

	SBSX75A-PMREC-BLK	SBSX-75A Panel Mount Receptacle Housing
	108G1	SBSX-75A Panel Mount Sealing Gasket
	2-8840P1	SBSX-75A Signal Housing - Red
	2-8840P2	SBSX-75A Signal Housing - Blue
	2-8840P3	SBSX-75A Signal Housing - Gray
	2-8840P4	SBSX-75A Signal Housing - Black



Panel Mount Plug Housing Kit		
Item	Ordering code	Description
	SBSX75A-PMPLUG-KIT-RED	SBSX-75A Panel Mount Plug Kit - Red Signal Housing
	SBSX75A-PMPLUG-KIT-BLU	SBSX-75A Panel Mount Plug Kit - Blue Signal Housing
	SBSX75A-PMPLUG-KIT-GRA	SBSX-75A Panel Mount Plug Kit - Gray Signal Housing
	SBSX75A-PMPLUG-KIT-BLK	SBSX-75A Panel Mount Plug Kit - Black Signal Housing

Loose parts included in the kits		
	SBSX75A-PMPLUG-BLK	SBSX-75A Panel Mount Plug Housing
	108G1	SBSX-75A Panel Mount Sealing Gasket
	2-8840P1	SBSX-75A Signal Housing - Red
	2-8840P2	SBSX-75A Signal Housing - Blue
	2-8840P3	SBSX-75A Signal Housing - Gray
	2-8840P4	SBSX-75A Signal Housing - Black

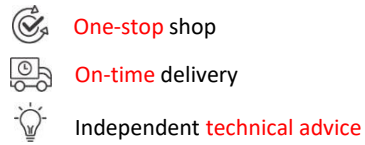

### Main Contacts Silver Plated

	1339G4-BK	Main contact – AWG 4 (21.2 mm <sup>2</sup> )
	1339G2-BK	Main contact – AWG 6 (13.3 mm <sup>2</sup> )
	1339G5-BK	Main contact – AWG 8 (8.4 mm <sup>2</sup> )
	1339G3-BK	Main contact – AWG 10/12 (5.3 – 3.3 mm <sup>2</sup> )





### Contacts for Auxiliary 4 Positions

	PM16P1416S30	PowerMod Pin AWG 16-14 Au.25 Standard Length 7.7mm
	PM16P1620S30	PowerMod Pin AWG 20-16 Au.25 Standard Length 7.7mm
	PM16P2024S30	PowerMod Pin AWG 24-20 Au.25 Standard Length 7.7mm
	PM16P1416A30	PowerMod Pin AWG 16-14 Au.25 Pre-Mate 9.3mm
	PM16P1620A30	PowerMod Pin AWG 20-16 Au.25 Pre-Mate 9.3mm
	PM16P2024A30	PowerMod Pin AWG 24-20 Au.25 Pre-Mate 9.3mm
	PM16P1416C30	PowerMod Pin AWG 16-14 Au.25 Post-Mate 6.6mm
	PM16P1620C30	PowerMod Pin AWG 20-16 Au.25 Post-Mate 6.6mm
	PM16P2024C30	PowerMod Pin AWG 24-20 Au.25 Post-Mate 6.6mm
	PM16S1416S32	PowerMod Socket AWG 16-14 Au.75
	PM16S1620S32	PowerMod Socket AWG 20-16 Au.75
	PM16S2024S32	PowerMod Socket AWG 24-20 Au.75



## SBSX-75A with 6 Position Signal Housing

### 6 Position Auxiliary Kits

Item	Ordering code	Description
	SBSX75A-6AUX-REC-KIT-WHT	SBSX-75A Receptacle Kit - 6 Position Signal Housing - White
	SBSX75A-6AUX-PLUG-KIT-WHT	SBSX-75A Male Plug Kit - 6 Position Signal Housing - White
	SBSX75A-6AUX-PMREC-KIT-WHT	SBSX-75A Panel Mount Receptacle Kit - 6 Position Signal Housing - White
	SBSX75A-6AUX-PMPLUG-KIT-WHT	SBSX-75A Panel Mount Plug Kit - 6 Position Signal Housing - White

### Loose parts included in the kits

	SBSX75A-REC-BLK	SBSX-75A Female Receptacle Housing
	SBSX75A-PLUG-BLK	SBSX-75A Male Plug Housing
	SBSX75A-PMREC-BLK	SBSX-75A Panel Mount Receptacle Housing
	SBSX75A-PMPLUG-BLK	SBSX-75A Panel Mount Plug Housing
	108G1	SBSX-75A Panel Mount Sealing Gasket <ul style="list-style-type: none"> <li>For Panel Mount Housings</li> </ul>
	2-8841P1	SBSX-75A Cable Clamp - Set of 2 <ul style="list-style-type: none"> <li>For inline housings</li> </ul>
	H1120P62	SBSX-75A Cable Clamp Screws <ul style="list-style-type: none"> <li>For inline housings</li> </ul>
	2-8860P1	SBSX-75A 6 Position Signal Housing - White
	2-8859P1	SBSX-75A 6 Position Contact Holder - Black

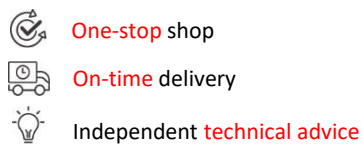

### Main Contacts Silver Plated

	1339G4-BK	Main contact – AWG 4 (21.2 mm <sup>2</sup> )
	1339G2-BK	Main contact – AWG 6 (13.3 mm <sup>2</sup> )
	1339G5-BK	Main contact – AWG 8 (8.4 mm <sup>2</sup> )
	1339G3-BK	Main contact – AWG 10/12 (5.3 – 3.3 mm <sup>2</sup> )



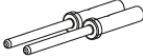
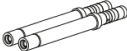

### Contacts for Auxiliary 6 Positions

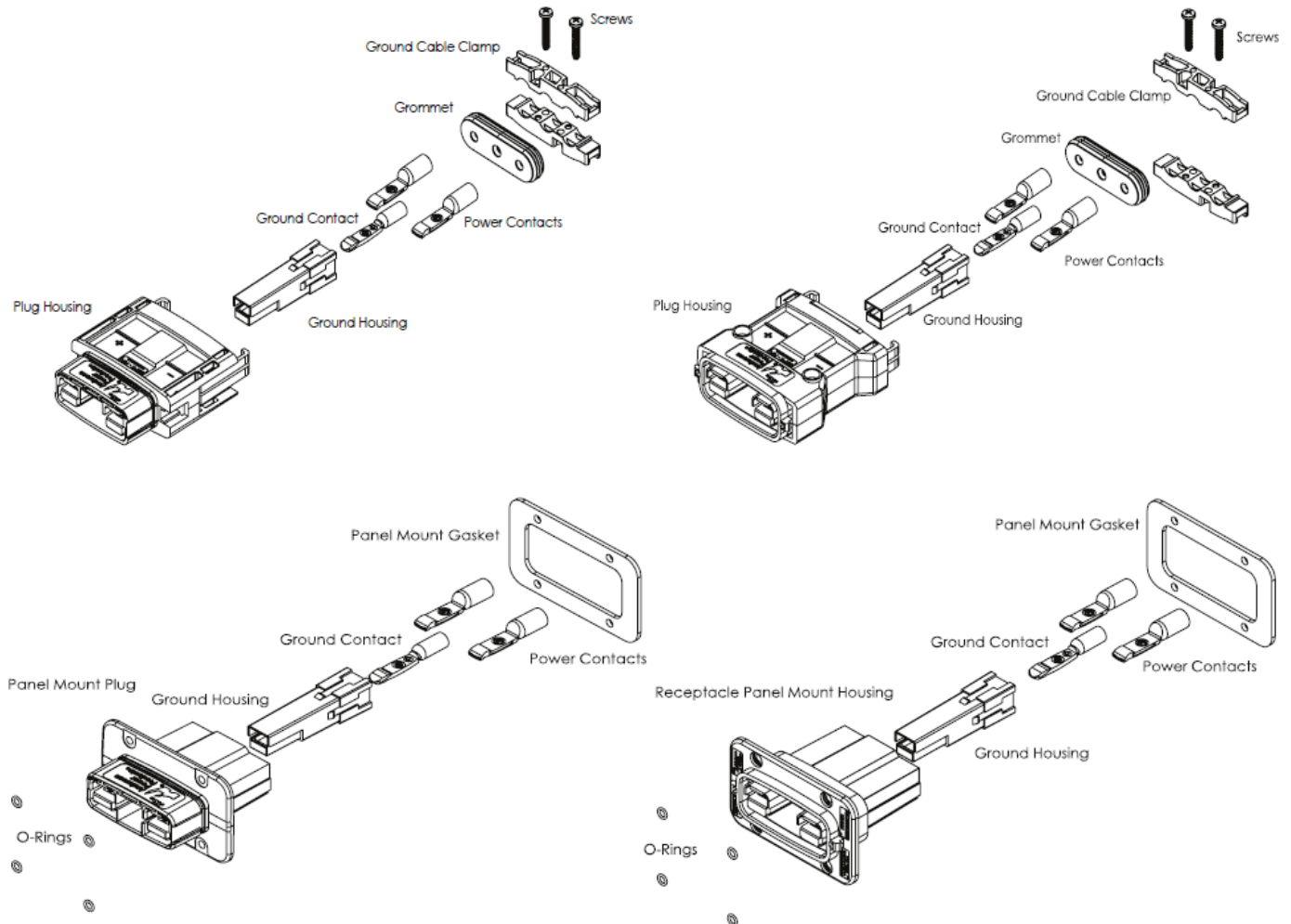
	4803G3-BK	PPMX AWG 20/24 PIN CONT.GOLD
	4802G3-BK	PPMX AWG 20/24 SOC.CONT.GOLD







## SBSX-75A with Ground Housing



### Ground Housing Kits

Item	Ordering code	Description
	SBSX75A-GND-REC-KIT-GRN	SBSX-75A Receptacle Kit - Green Signal Housing (Ground)
	SBSX75A-GND-PLUG-KIT-GRN	SBSX-75A Plug Kit - Green Signal Housing (Ground)
	SBSX75A-GND-PMREC-KIT-GRN	SBSX-75A Panel mount Receptacle Kit - Green Signal Housing (Ground)
	SBSX75A-GND-PMPLUG-KIT-GRN	SBSX-75A Panel Mount Plug Kit - Green Signal Housing (Ground)

### Loose parts included in the kits

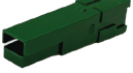
	SBSX75A-REC-BLK	SBSX-75A Female Receptacle Housing
	SBSX75A-PLUG-BLK	SBSX-75A Male Plug Housing
	SBSX75A-PMREC-BLK	SBSX-75A Panel Mount Receptacle Housing
	SBSX75A-PMPLUG-BLK	SBSX-75A Panel Mount Plug Housing
	108G1	SBSX-75A Panel Mount Sealing Gasket <ul style="list-style-type: none"> <li>For Panel Mount Housings</li> </ul>
	2-8863P1	SBSX-75A Ground Cable Clamp <ul style="list-style-type: none"> <li>For inline housings</li> </ul>
	H1120P62	SBSX-75A Cable Clamp Screws <ul style="list-style-type: none"> <li>For inline housings</li> </ul>
	B02893G1	SBSX-75A Ground Housing Assembly - Green

### Main Contacts and Ground Contacts Silver Plated



	1339G4-BK	Main contact – AWG 4 (21.2 mm <sup>2</sup> )
	1339G2-BK	Main contact – AWG 6 (13.3 mm <sup>2</sup> )
	1339G5-BK	Main contact – AWG 8 (8.4 mm <sup>2</sup> )
	1339G3-BK	Main contact – AWG 10/12 (5.3 – 3.3 mm <sup>2</sup> )

### Ground Contacts Silver Plated (Pre-Mate)

	1340G1-BK	Pre-Mate Contact – AWG 6 (13.3 mm <sup>2</sup> )
	1340G2-BK	Pre-Mate Contact – AWG 8 (8.4 mm <sup>2</sup> )
	1340G3-BK	Pre-Mate Contact – AWG 10/12 (5.3 – 3.3 mm <sup>2</sup> )

## Covers and Grommets

### Covers

	SBSX75A-REC-COVER	SBSX-75A Sealed Cover - Receptacle Side <ul style="list-style-type: none"> <li>O-ring included</li> </ul>
	SBSX75A-PLUG-COVER	SBSX-75A Sealed Cover - Plug Side
	SBSX75A-PMREC-COVER	SBSX-75A Sealed Cover - Panel Mount Receptacle Side <ul style="list-style-type: none"> <li>O-ring included</li> </ul>

### Grommets Discrete Wire Power and Signal

	D-150-060	SBSX-75A AWG 10/12 Discrete Wire Sealing Grommet / Signal OD 0.08-0.10 mm
	D-310-060	SBSX-75A AWG 4/6 Discrete Wire Sealing Grommet / Signal OD 0.08-0.10 mm

### Grommets Power Only

	NS-150	SBSX-75A Cable Grommet / Power OD 3.81-4.57 mm - No Signal
	NS-240	SBSX-75A Cable Grommet / Power OD 6.10-6.86 mm - No Signal
	NS-310	SBSX-75A Cable Grommet / Power OD 7.87-8.64 mm - No Signal
	NS-410	SBSX-75A Cable Grommet / Power OD 10.41-11.18 mm - No signal

**Grommets Jacket Cable Power and Signal**

	J-150-150	SBSX-75A Jacketed Signal Cable Grommet / Power OD 3.81-4.57 mm / Signal OD 3.81-4.57 mm
	J-150-180	SBSX-75A Jacketed Signal Cable Grommet / Power OD 3.81-4.57 mm / Signal OD 4.57-5.33 mm
	J-150-320	SBSX-75A Jacketed Signal Cable Grommet / Power OD 3.81-4.57 mm / Signal OD 8.13-8.89 mm
	J-150-350	SBSX-75A Jacketed Signal Cable Grommet / Power OD 3.81-4.57 mm / Signal OD 8.89-9.65 mm
	J-150-380	SBSX-75A Jacketed Signal Cable Grommet / Power OD 3.81-4.57 mm / Signal OD 9.65-10.41 mm
	J-150-410	SBSX-75A Jacketed Signal Cable Grommet / Power OD 3.81-4.57 mm / Signal OD 10.41-11.18 mm
	J-240-150	SBSX-75A Jacketed Signal Cable Grommet / Power OD 6.10-6.86 mm / Signal OD 3.81-4.57 mm
	J-240-180	SBSX-75A Jacketed Signal Cable Grommet / Power OD 6.10-6.86 mm / Signal OD 4.57-5.33 mm
	J-240-320	SBSX-75A Jacketed Signal Cable Grommet / Power OD 6.10-6.86 mm / Signal OD 8.13-8.89 mm
	J-240-350	SBSX-75A Jacketed Signal Cable Grommet / Power OD 6.10-6.86 mm / Signal OD 8.89-9.65 mm
	J-240-380	SBSX-75A Jacketed Signal Cable Grommet / Power OD 6.10-6.86 mm / Signal OD 9.65-10.41 mm
	J-240-410	SBSX-75A Jacketed Signal Cable Grommet / Power OD 6.10-6.86 mm / Signal OD 10.41-11.18 mm
	J-310-150	SBSX-75A Jacketed Signal Cable Grommet / Power OD 7.87-8.64 mm / Signal OD 3.81-4.57 mm
	J-310-180	SBSX-75A Jacketed Signal Cable Grommet / Power OD 7.87-8.64 mm / Signal OD 4.57-5.33 mm
	J-310-310	SBSX-75A Jacketed Signal Cable Grommet / Power OD 7.87-8.64 mm / Signal OD 7.87-8.64 mm
	J-310-320	SBSX-75A Jacketed Signal Cable Grommet / Power OD 7.87-8.64 mm / Signal OD 8.13-8.89 mm
	J-310-350	SBSX-75A Jacketed Signal Cable Grommet / Power OD 7.87-8.64 mm / Signal OD 8.89-9.65 mm
	J-310-380	SBSX-75A Jacketed Signal Cable Grommet / Power OD 7.87-8.64 mm / Signal OD 9.65-10.41 mm
	J-310-410	SBSX-75A Jacketed Signal Cable Grommet / Power OD 7.87-8.64 mm / Signal OD 10.41-11.18 mm
	J-410-150	SBSX-75A Jacketed Signal Cable Grommet / Power OD 10.41-11.18mm / Signal OD 3.81-4.57 mm
	J-410-180	SBSX-75A Jacketed Signal Cable Grommet / Power OD 10.41-11.18mm / Signal OD 4.57-5.33 mm
	J-410-320	SBSX-75A Jacketed Signal Cable Grommet / Power OD 10.41-11.18mm / Signal OD 8.13-8.89 mm
	J-410-350	SBSX-75A Jacketed Signal Cable Grommet / Power OD 10.41-11.18mm / Signal OD 8.89-9.65 mm
	J-410-380	SBSX-75A Jacketed Signal Cable Grommet / Power OD 10.41-11.18mm / Signal OD 9.65-10.41 mm
J-410-410	SBSX-75A Jacketed Signal Cable Grommet / Power OD 10.41-11.18mm / Signal OD 10.41-11.18 mm	



## Panel Mount Receptacle

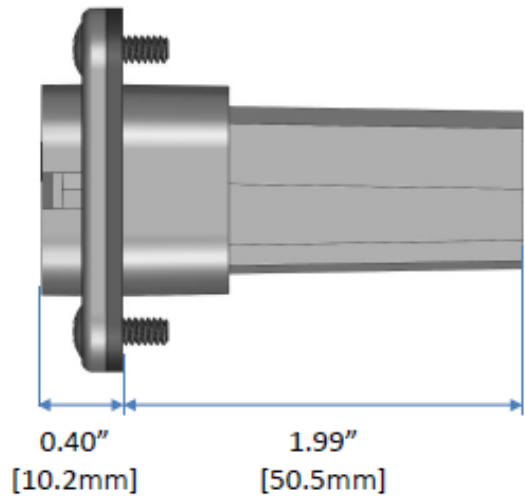
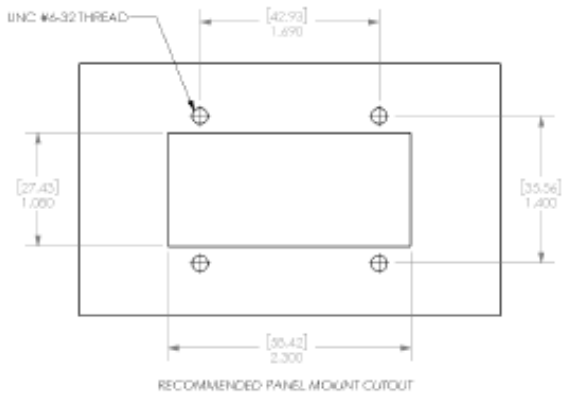
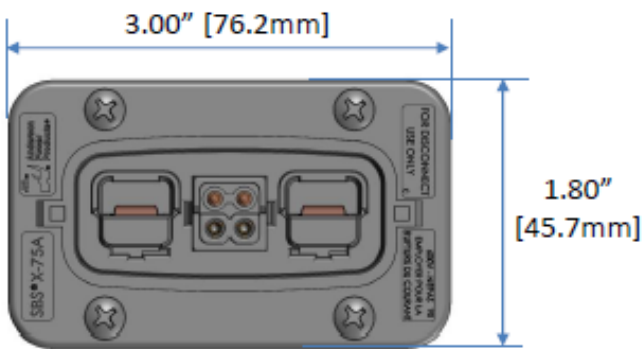



## Panel Mount Plug

